

# SATURN SLIM II 80 P/N-Z, W

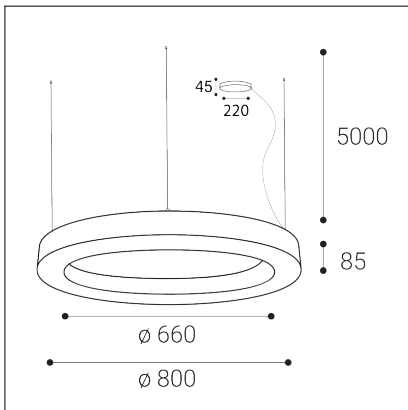

<b>Code:</b>	3276471DT
<b>Color:</b>	WHITE / 9003
<b>Material:</b>	ALUMINIUM/PMMA
<b>Power:</b>	80W (50+30)
<b>Color temperature:</b>	2700K/3000K/4000K
<b>Lumen output:</b>	3500+2100lm
<b>Efficacy:</b>	70lm/W
<b>Color rendering index:</b>	90+
<b>SDCM:</b>	< 3
<b>Light beam angle:</b>	160°
<b>Light Source:</b>	LED
<b>Dimmable:</b>	TRIAC
<b>LED lifetime:</b>	L80B20 50.000h
<b>Driver:</b>	1300 + 750 mA
<b>Voltage / Frequency:</b>	220-240V AC, 50-60Hz
<b>Dimensions luminaire:</b>	d800x85 mm
<b>Product weight kg:</b>	7.5
<b>Length suspension:</b>	5000 mm
<b>Package dimensions:</b>	850x850x120 mm

