

LINEAR II 2, B

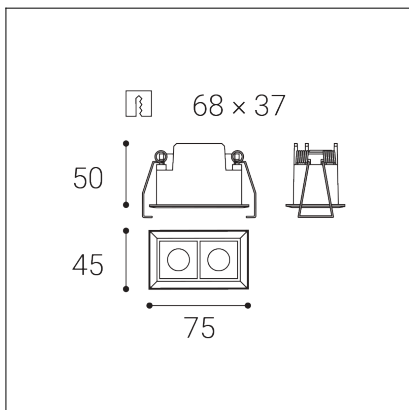

Code: 2491253DT
Color: BLACK / 9005
Material: ALUMINIUM/PC
Power: 4W
Color temperature: 3000K/3500K/4000K
Lumen output: 320lm
Efficacy: 80lm/W
Color rendering index: 90+
SDCM: < 3
Light beam angle: 45°
Light Source: LED
Dimmable: TRIAC
LED lifetime: L80B20 50.000h
Driver: 250 mA
Voltage / Frequency: 220-240V AC, 50-60Hz
Dimensions luminaire: 75x45x50 mm
Installation hole: 68 x 37 mm
Product weight kg: 0.16
Package dimensions: 105x55x85 mm

