

JOTA II 26, W

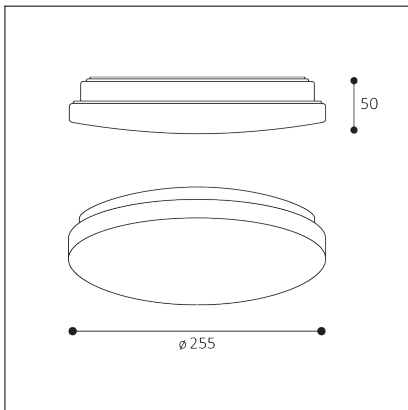

Code:	1470151D
Color:	WHITE / RAL 9003
Material:	STEEL/PMMA
Power:	12W
Color temperature:	3000K/4000K
Lumen output:	1200lm
Efficacy:	100lm/W
Color rendering index:	80+
SDCM:	< 3
Light beam angle:	160°
Light Source:	LED
Dimmable:	DALI/PUSH
LED lifetime:	L80B20 50.000h
Driver:	300 mA
Voltage / Frequency:	220-240V AC, 50-60Hz
Max. units per circuit output:	B10:28, B16:45, B20:57, C10:28, C16:45, C20:57
Dimensions luminaire:	d255x50 mm
Product weight kg:	0.4
Packing carton:	1
Package dimensions:	282x282x60 mm
Remark:	wall mountable - yes

