

■ ZHAGA Microwave Sensor For High Bay Light ANT-5-ZT Instruction



ANT-5-ZT



RC-100

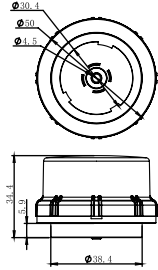

INTRODUCTION

ANT-5-ZT is mounts in an outdoor lighting fixture(street lighting, garden lighting, passageway lighting) and provides multi-level control based on motion and/or daylight contribution. This product provides twist lock terminals meeting the requirements of ZHAGA BOOK 18.

It controls 0-10 VDC LED drivers or dimming ballasts, and is rated for wet and cold locations. All control parameters are adjustable via a wireless configuration tool capable of storing.

SPECIFICATIONS

Power supply	12V~24V DC, >50mA
Dim control output	0-10V, max. 25mA sinking current
HF System	5.8GHz±75MHz
Transmission power	<0.2mW
Detection radius	20%/50%/75%/100%(1-8m)
Mounting height	Max 40ft.(12meters)
Time setting	10s/1min/5min/10min/15min/20min/30min/60min
Light-control	24H/10LUX/30LUX/50LUX
Temperature	-4°F ~ +140°F (-20°C ~ +60°C)
IP rating	IP65

⚠ WARNING

NOTE: Warm up time is 15seconds. After the sensor connects input power first time, the light will keep on 15seconds, then go to dimming to work normally.

NOTE: Factory Default Setting: 100% sensitivity, Hold on time: 5min, Daylight sensor is ☀, Dimming level: 30%, Dimming time: 60minutes.

NOTE: Any setting changed by remote control, the led light that sensor connect will on/off as confirm.

CORRIDOR FUNCTION

This function inside the motion sensor to achieve tri-level control, for some areas which require a light change notice before switch-off. The sensor offers 3 levels of light: 100%-->dimmed light (natural light is insufficient) -->off; and 2 periods of selectable waiting time: motion hold-time and stand-by period; Selectable daylight threshold and freedom of detection area.

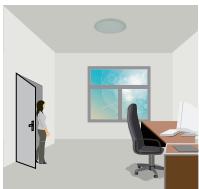

With sufficient natural light, the light does not switch on when presence is detected.

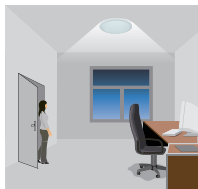

With insufficient natural light, the sensor switches on the light automatically when presence is detected.

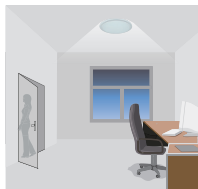

After hold-time, the light dims to stand-by level if the surrounding natural light is below the daylight threshold.



Light switches off automatically after the stand-by period elapses.

ZHAGA Microwave Sensor For High Bay Light ANT-5-ZT Instruction

DAYLIGHT SENSOR FUNCTION

Open the daylight sensor by push **(II)** when remote control is in setting condition.



The light switches on at 100% when there is movement detected.

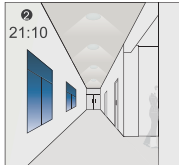

The light dims to stand-by level after the hold-time.

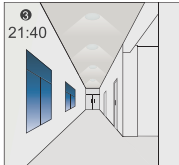

The light remains in dimming level at night.

Settings on this demonstration:

Hold-time: 30min

Setpoint on:50lux

Setpoint off:300lux

Stand-by Dim: 10%

Stand-by period: +∞

(when the smart photocell sensor open, the stand-by time is only +∞)

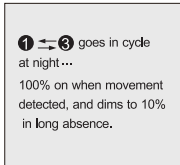

① → ② → ③ goes in cycle at night...

100% on when movement detected, and dims to 10% in long absence.



When the natural light level exceeds setpoint off to light, the light will turn off even if when the space is occupied.

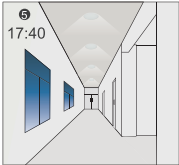

The light automatically turns on at 10% when natural light is insufficient (no motion).

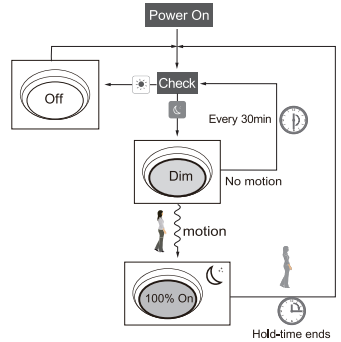

SENSOR COVERAGE

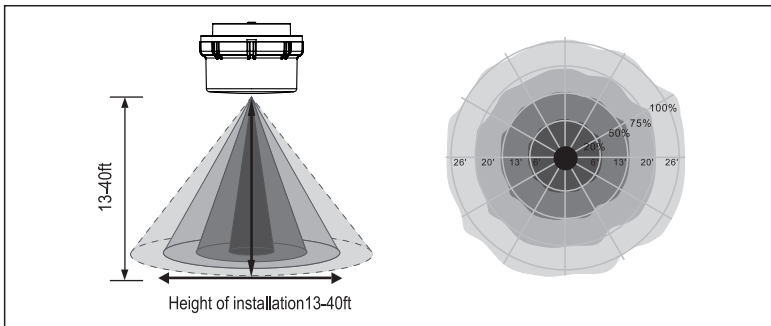

PORT DESCRIPTION

- Port 1 : 12-24Vdc
- Port 2 : GND/DIM -
- Port 3 : NC
- Port 4 : DIM +

